

TerminEdge & TerminEdge One Fascia

Hickman Edge Systems continues our tradition of innovatively designed rigorously tested roof edge systems with this versatile roof edge fascia system. TerminEdge and TerminEdge One Fascia Systems provide superior protection from wind and water penetration with economical pricing to maximize your profits. Our fast lead times and easy installation translate directly into decreased labor costs and enable you to move on to other projects more quickly.

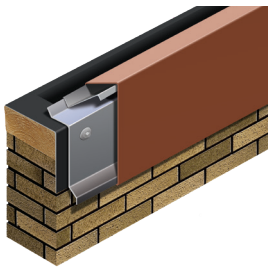

TerminEdge Fascia Single-Ply



TerminEdge One Fascia Single-Ply



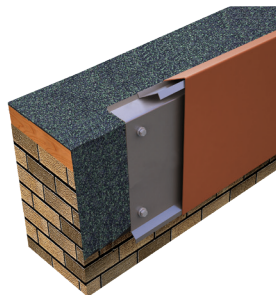

TerminEdge One Extended MB Fascia Built-up or Modified

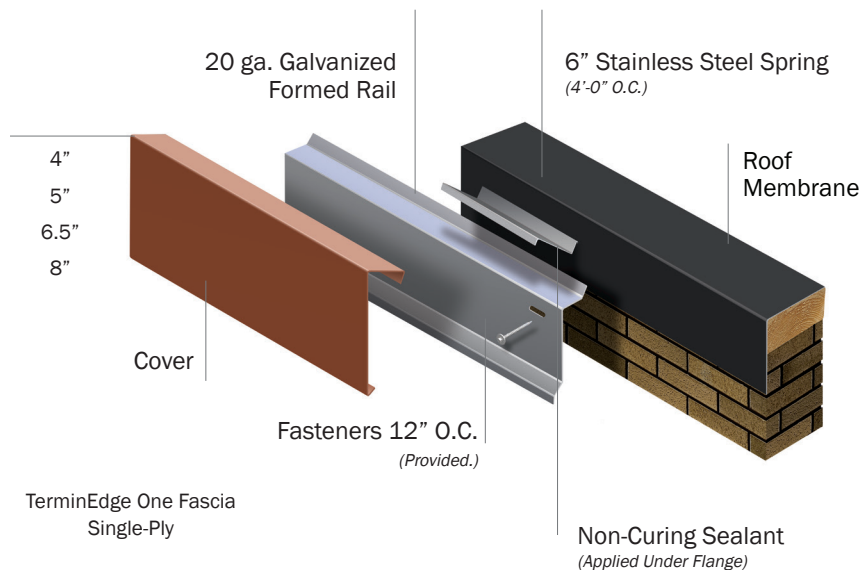

TerminEdge At-A-Glance

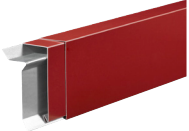
- » 20 Year, 120 MPH Wind Warranty
- » ANSI/SPRI/FM 4435/ES-1 Tested
- » FM Approved for Wind Uplift Protection
- » Miami-Dade County Approved
- » Variety of Colors, Sizes & Materials
- » Easy Install = Decreased Labor Costs

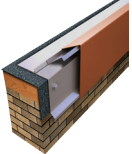

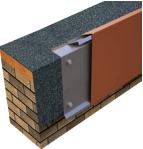
PRODUCT NAME	APPLICATION	DESIGN FEATURES	WIND WARRANTY	STANDARD SIZES	COVER MATERIALS	ANSI/SPRI/FM 4435/ ES-1 TESTED	FM APPROVED	MIAMI-DADE COUNTY APPROVED
 TERMINEDGE FASCIA	Fully Adhered or Mechanically Attached Single-Ply	Snap-on Cover 20 ga. Cleat	20 Year, 120 MPH	3.5" 4.75" 6.25" 7.75" 9.25" 10.75" 12.25"	24 ga. 22 ga. .040" .050"	X*	X*	X*
 TERMINEDGE ONE FASCIA	Fully Adhered or Mechanically Attached Single-Ply	Snap-on Cover 20 ga. Cleat Spring Clips	20 Year, 120 MPH	4" 5" 6.5" 8"	24 ga. 22 ga. .040" .050" .063"	X	X	X
 TERMINEDGE ONE MB FASCIA	Built-up or Modified	Snap-on Cover 20 ga. Cleat Spring Clips	20 Year, 120 MPH	5" 6.5" 8	24 ga. 22 ga. .040" .050" .063"	X	X	X
 TERMINEDGE ONE EXTENDED FASCIA	Fully Adhered or Mechanically Attached Single-Ply	Snap-on Cover 20 ga. Cleat Spring Clips	20 Year, 120 MPH	9.5" 11" 12.5"	22 ga. .050" .063"	X	X	X
 TERMINEDGE ONE EXTENDED MB FASCIA	Built-up or Modified	Snap-on Cover 20 ga. Cleat Spring Clips	20 Year, 120 MPH	9.5" 11" 12.5"	22 ga. .050" .063"	X	X	X

*MAX TESTED 9.25' FACE HEIGHT

10 Express Colors for Quick Shippi Express, standard, and premium colors and finishes are available to meet your job requirements and includes a 30-year Kynar 500® finish warranty on coil-coated standard colors. Custom colors are also available. For the most accurate color representation, contact us to request a paint chip.

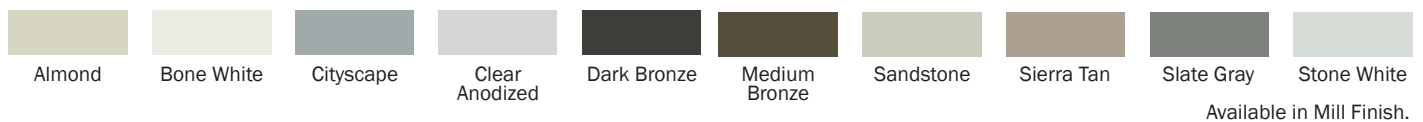

4 Commerce Way | Arden, NC 28704
 (828) 676-1700 | www.hickmanedgesystems.com
 Copyright ©2024. All rights reserved.

