

IN WALL DRIVE-LOCK REGLET

REGLET VERSION

INSTALLATION INSTRUCTIONS

STEP 1 - REGLET RECEIVER

INSTALL REGLET RECEIVER INTO 1" DEEP SAWCUT OR MORTAR JOINT. SAWCUT SHALL BE CUT TRUE AND LEVEL A MINIMUM OF 7" ABOVE THE HIGH POINT OF THE CANT STRIP (IF USED). INSTALL FROM RIGHT TO LEFT. LAP ENDS OF REGLET 3" AT FACTORY NOTCHED END.

NOTE: REMOVE PROTECTIVE FILM IMMEDIATELY.

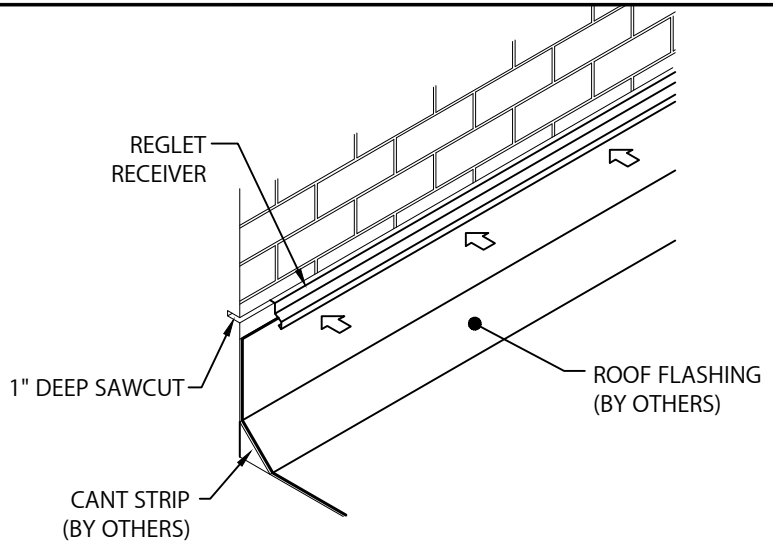

STEP 2 - COUNTERFLASHING

PRIOR TO INSTALLING COUNTERFLASHING, REMOVE PROTECTIVE FILM. HOOK COUNTERFLASHING ONTO RECEIVER AS SHOWN IN FIG. A. ROTATE DOWNWARD INTO PLACE (FIG. B). STAGGER REGLET RECEIVER AND COUNTERFLASHING JOINTS ACCORDINGLY.

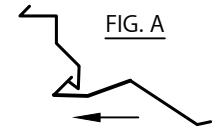
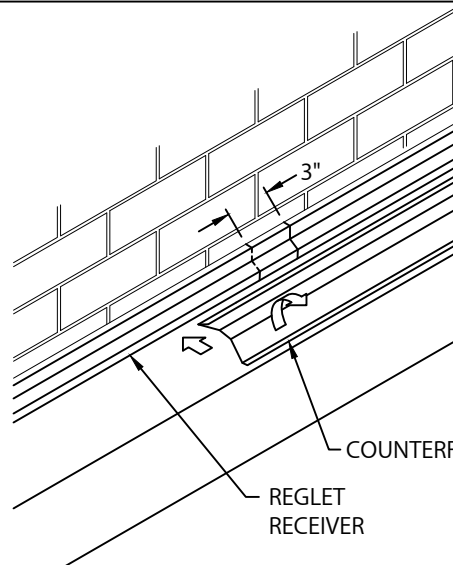

FIG. A
HOOK COUNTERFLASHING ON REGLET

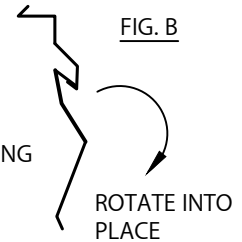

FIG. B
ROTATE INTO PLACE

STEP 3 - COUNTERFLASHING

REMOVE PROTECTIVE FILM. HOOK COUNTERFLASHING ONTO RECEIVER AS SHOWN IN FIG. C. SLIDE COUNTERFLASHING 3" AT LAP JOINT OVER PREVIOUSLY INSTALLED PIECE. ROTATE DOWNWARD INTO PLACE AS SHOWN IN STEP 2.

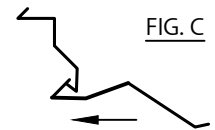
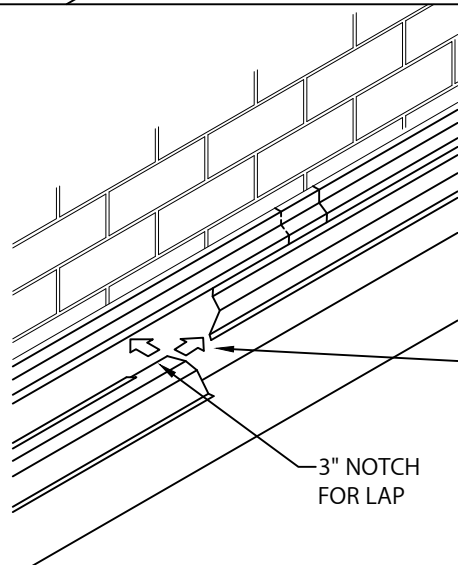

FIG. C
HOOK COUNTERFLASHING ON REGLET

IN WALL DRIVE-LOCK REGLET

REGLET VERSION

INSTALLATION INSTRUCTIONS

HIGH GRADE ARCHITECTURAL
SEALANT (BY OTHERS)

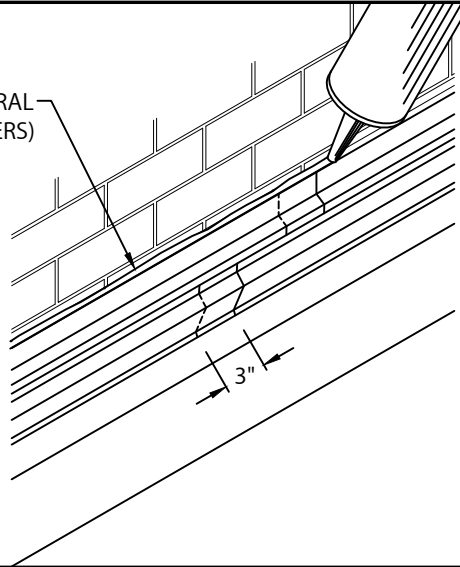

STEP 4 - COMPLETION
APPLY A CONTINUOUS BEAD OF HIGH
GRADE ARCHITECTURAL SEALANT IN
CAULK CUP OF REGLET TO COMPLETE
INSTALLATION.

TYPICAL INSTALLATION

